

# Product Datasheet

## Park Bench ŁP-09

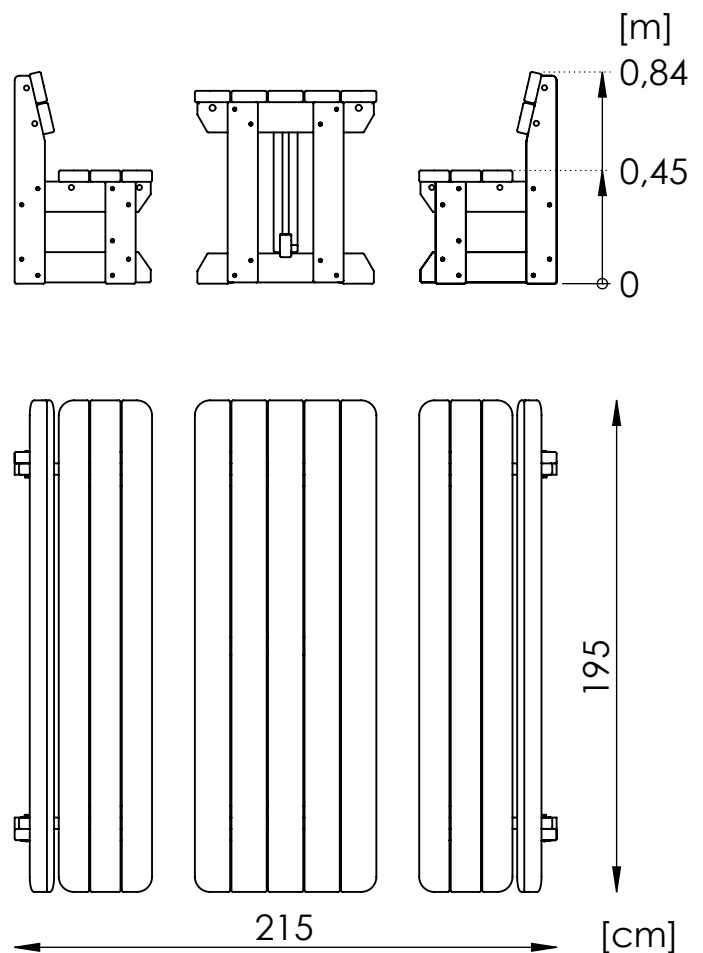

### Materials used:

- construction of bench is made of boards with a section of 45x120 mm, pressure impregnated
- fasteners, hardened galvanized screws

### Assembly:

The bench is freestanding or bench is mounted in the ground using hot-dip galvanized steel anchors. Foundations made of C20/25 class concrete.